







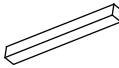
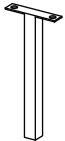
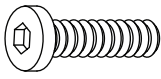
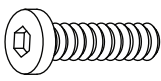
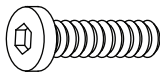

| | | | | |
|--|---|---|--|--|
| <p>1.x2</p>  <p>Short Tube</p> | <p>2.x2</p>  <p>Long Tube</p> | <p>3.x2</p>  <p>Support Legs</p> | <p>4.x4</p>  <p>Support Legs</p> | |
| <p>K.x8</p>  <p>M8x20 Screw</p> | | | | |
| <p>A.x16</p>  <p>M8x40 Screw</p> | <p>B.x2</p>  <p>M8x50 Screw</p> | <p>C.x24</p>  <p>M8 Nut</p> | <p>D.x1</p>  <p>Open End Wrench</p> | <p>E.x1</p>  <p>M6 Wrench</p> |
| <p>F.x20</p>  <p>Solid Wood Bed Slats</p> | <p>G.x40</p>  <p>Slatted Single Clip</p> | <p>H.x4</p>  <p>Bent Sub</p> | <p>I.x4</p>  <p>Triangular Connector</p> | |

STEP 1

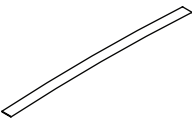
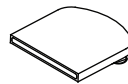

STEP 2

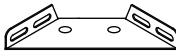
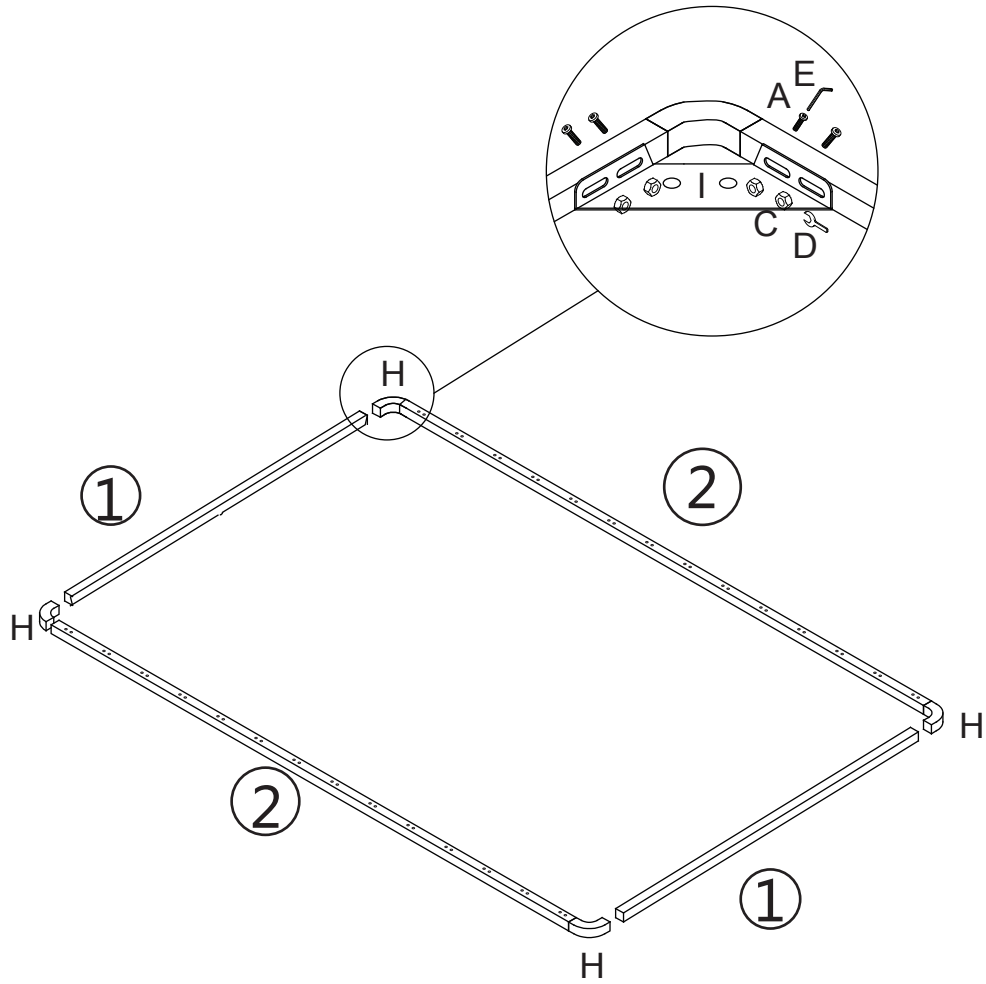
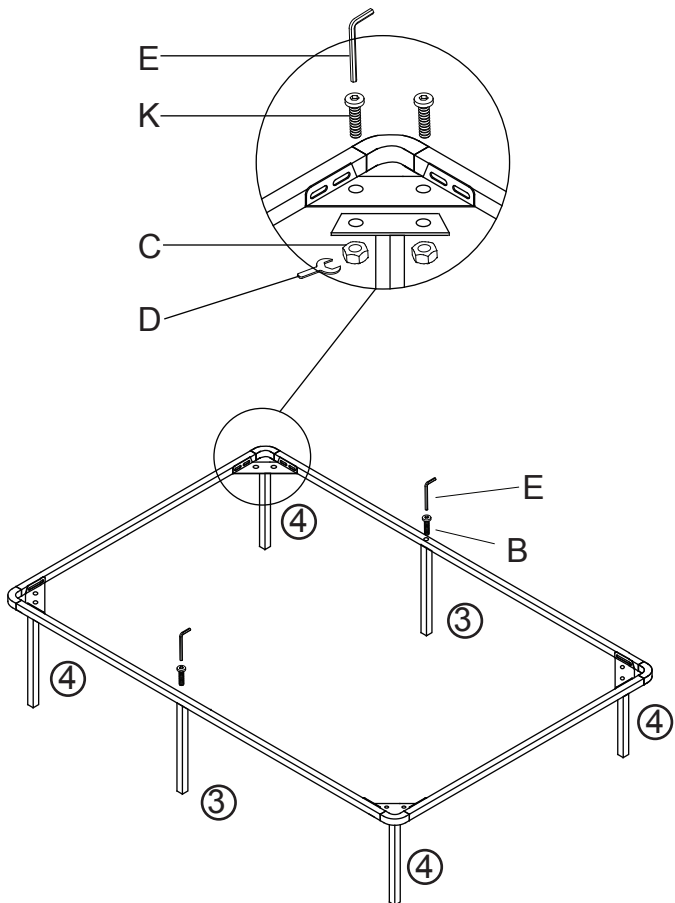

STEP 3

